

SINGER

241-

20064

INSTRUCTIONS
FOR USING AND ADJUSTING
SINGER^{*}
HIGH SPEED MACHINES

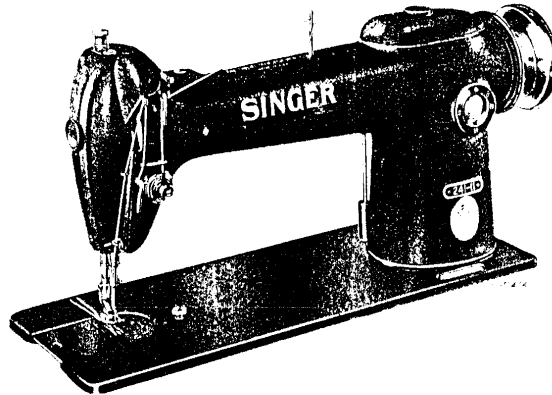

OF
CLASS 241-
SINGLE NEEDLE LOCK STITCH

* A TRADE MARK OF

THE SINGER MANUFACTURING CO.

TO ALL WHOM IT MAY CONCERN:

The improper placing or renewal of the Trade Mark "SINGER" or any other of the Trade Marks of The Singer Manufacturing Company (all of which are duly Registered Trade Marks) on any machine that has been repaired, rebuilt, reconditioned, or altered in any way whatsoever outside a SINGER factory or an authorized SINGER agency is forbidden.

DESCRIPTION

The Singer Class 241 is a high speed, single needle, lock stitch machine with a completely automatic lubricating system. It has a gear-driven, lubricated rotary sewing hook and a drop feed.

The following list shows the class of work handled and other details of the three varieties of this class:

Machine	Class of Work	Stitches per inch	Needle Bar Stroke	Presser Bar Lift
241-11	Light and Medium Weight	7 to 30	1 9/64"	9/32"
241-12	Medium and Medium Heavy	5½ to 30	1 13/64"	5/16"
241-13	Heavy and Extra-Heavy	5½ to 30	1 7/16"	3/8" †

† Optional 7/16"

SPEED

Maximum speed of Machines 241-11 and 241-12 is 5000 stitches per minute.

Maximum speed of Machine 241-13 is 4300 stitches per minute.

THE IMPORTANCE OF
USING **SINGER*** PARTS AND NEEDLES
IN **SINGER** MACHINES

The successful operation of SINGER machines can only be assured if SINGER parts and needles are used. Supplies are available at all SINGER Shops for the Manufacturing Trade, and mail orders will receive prompt attention.

Setting Up

When shipped, the base is held to the machine by a single bolt through the bottom of the base. Remove this bolt and plug the hole by inserting, from inside the base, the special cap screw (C, Fig. 2) furnished with the machine.

The base fits into a standard table cut-out and rests on the four corners without bolting. If an old plank is used, remove the old knee lifter brackets and remove the four felt pads from the corners of the cutout. Also rasp the edges of the cutout if necessary, as the base must slide in without driving, and must be located so that the machine head does not touch the table when it is placed on the base. Use shims on the corners if necessary to prevent the base from rocking. It should also be level in both directions so that the oil level will be indicated accurately by the marks in the base.

See that the plunger (F, Fig. 2) is in place inside the base before putting the machine on the base. The machine head rests on the thick cork gasket in the base and is not bolted down. The machine hinges must not support the head except when it is tilted back.

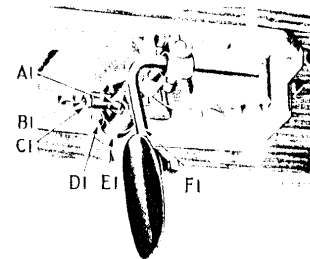

Fig. 1. Adjustment of the Knee Lifter

The knee lifter is shipped assembled to the base except for the knee plate and lever (F1, Fig. 1). After the base is in position, loosen the set screws (A1 and D1, Fig. 1), slide the shaft forward to the position shown, and attach the knee lifter lever (F1). Set the stop screw (B1) so that there is only a little play of the lifter before it starts to lift the presser bar, then hold the screw and tighten lock nut (C1). Set the rear stop dog (E1) to allow the presser bar to be just raised all the way but not to allow any further strain on the knee lifter parts or any tendency to lift the machine from the base.

Lubrication

Machines of Class 241 have an automatic lubricating system in which oil is circulated from a reservoir in the base. See "X-ray" view on pages 12 and 13.

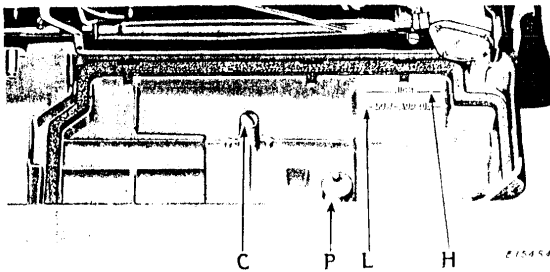

Fig. 2. Oil Reservoir

BEFORE STARTING THE MACHINE, this reservoir must be filled to the "high" mark (H, Fig. 2) with "TYPE A" or "TYPE C" OIL, sold only by Singer Sewing Machine Company. The reservoir holds approximately $1\frac{1}{2}$ pints.

When in operation, the oil level in the reservoir should be inspected at least twice a month or as often as necessary to keep it from going below the "low" mark (L) in the reservoir. Refill to "high" mark with "TYPE A" or "TYPE C" OIL.

The correct operation of the lubricating system is shown by a continuous stream of oil passing the window (W) in the arm while the machine is running. If this flow should stop, the machine should be immediately stopped and not run until the cause has been determined.

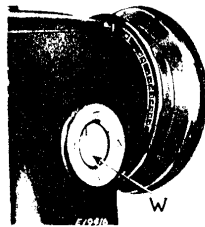

Fig. 3
Oil Flow Window

NOTE: Before starting a machine which has been standing idle for several weeks, it is advisable to remove the face plate and oil the needle bar and take-up bearings. The automatic oiling system will lubricate these bearings after the first few minutes.

The sewing hook is automatically lubricated, but if more or less oil is desired on the hook race, see instructions on page 21. Also see "hints" on page 7.

Needles

Needles for these machines are as follows:

Machine	Class and Variety	Sizes
241-11	88x9	7, 8, 9, 10, 11, 12, 13, 14, 16, 17, 18, 19, 21
241-12 and 241-13	16x257	8, 9, 10, 11, 12, 13, 14, 16, 17, 18, 19, 21,
241-13 with 7/16" presser bar lift	16x261	13, 14, 16, 17, 18, 19, 21

The above needles are regularly nickel finish but are available with chromium finish if ordered.

The size of the needle to be used should be determined by the size of the thread which must pass freely through the eye of the needle. Rough or uneven thread, or thread which passes with difficulty through the eye of the needle, will interfere with the successful use of the machine.

Orders for needles must specify the QUANTITY required, the SIZE NUMBER, also the CLASS and VARIETY NUMBERS separated by an x.

The following is an example of an intelligible order:

"100 No. 16, 88x9 Needles
50 No. 18, 16x257 Needles"

The best stitching results will be obtained by using the needles furnished by Singer Sewing Machine Company.

Thread

Left twist thread should be used in the needle. Either right or left twist thread can be used in the bobbin.

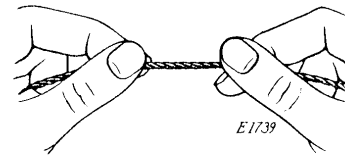

Fig. 4 How to Determine the Twist

Hold the thread as shown above. Turn the thread over toward you between the thumb and forefinger of the right hand; if left twist, the strands will wind tighter; if right twist, the strands will unwind.

Relative Sizes of Needles and Thread

The following sizes of needles and thread are recommended according to the class of work:

Sizes of Needles	Classes of Work	Sizes of Cotton, Linen or Silk
14	Shirtings, Sheetings, Calicoes, Muslins, Silks, Dress Goods and all classes of general work.	60 to 80 Cotton A and B Silk
16 and 17	All kinds of heavy Calicoes, light Woolen Goods, heavy Silk, Seaming, Stitching, etc.	40 to 60 Cotton C Silk
18	Tickings, Upholstery, Woolen Goods, Trousers, Boys' Clothing, Cloaks, etc.	30 to 40 Cotton D Silk
19	Heavy Woolens, Tickings, Bags, Heavy Coats, Trousers, Heavy Clothing generally.	20 to 30 Cotton E Silk 60 to 80 Linen
21	Bags, Coarse Cloths and Heavy Goods.	16 to 20 Cotton 40 to 60 Linen

Hints for Perfect Operation

The balance wheel must always turn over toward the operator.

Do not run the machine with the presser foot resting on the feed without cloth under the presser foot.

Do not run the machine when both bobbin case and needle are threaded unless there is material under the presser foot.

Do not try to help the machine by pulling the fabric lest you bend the needle. The machine feeds the work without assistance.

The slide over the bobbin case should be kept closed when the machine is in operation.

Do not press on the knee lifter lever while the machine is in operation, as this might prevent the work from feeding properly.

If the sewing hook should become excessively warm, it may be that there is an insufficient supply of oil to the hook. To determine whether the oil is properly flowing to the hook, withdraw the bed slide and hold a piece of thin paper under the hook while the machine runs for a few seconds. There should be a slight trace of oil on the paper. If there is not, adjust the oil flow regulator or replace the oil filter as instructed on pages 21 or 22.

NEVER TOUCH THE STITCH REGULATOR PLUNGER WHEN THE MACHINE IS RUNNING.

To Remove the Bobbin

Turn the balance wheel over toward you until the needle moves up to its highest point. Draw out the slide in the bed of the

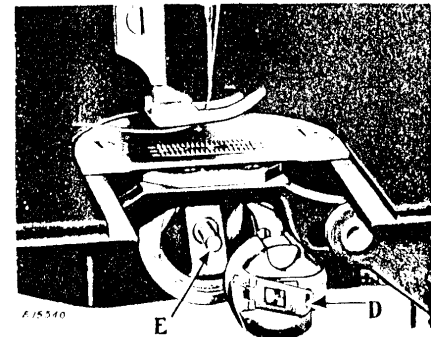

Fig. 5. Removing the Bobbin

machine. Open the bobbin case latch (D, Fig. 5) and, by means of this latch, remove the bobbin case from the sewing hook.

While the latch remains open, the bobbin will be retained in the bobbin case. Release the latch, turn the open end of the bobbin case downward and the bobbin will drop out.

To Wind the Bobbin

(See Fig.6)

Fasten the bobbin winder to the table with its driving pulley in front of the machine belt, so that the pulley will drop away from the belt when sufficient thread has been wound upon the bobbin.

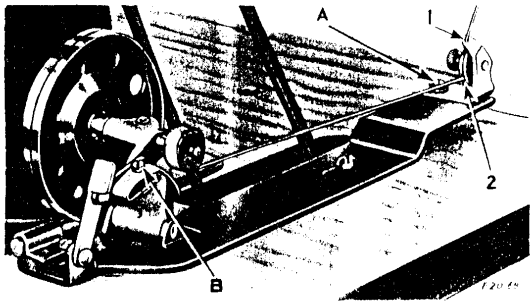

Fig. 6. Winding the Bobbin

Place the bobbin on the bobbin winder spindle and push it on as far as it will go.

Pass the thread down through the thread guide (1) in the tension bracket, around the back of, and between, the tension discs (2). Then wind the end of the thread around the bobbin a few times, push the bobbin winder pulley over against the machine belt and start the machine.

When sufficient thread has been wound upon the bobbin, the bobbin winder will stop automatically.

If the thread does not wind evenly on the bobbin, loosen the screw (A) in the tension bracket and move the bracket to the right or left as may be required, then tighten the screw.

The amount of thread wound on the bobbin is regulated by the screw (B). To wind more thread on the bobbin, turn the screw (B) inwardly. To wind less thread on the bobbin, turn this screw outwardly.

Bobbins can be wound while the machine is stitching.

To Thread the Bobbin Case

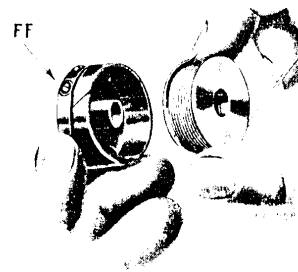

Fig. 7

Hold the bobbin between the thumb and forefinger of the right hand, as shown in Fig.7, the thread drawing on the bottom from the left toward the right.

With the left hand hold the bobbin case as shown in Fig. 7, the slot in the edge being near the top, and place the bobbin into it.

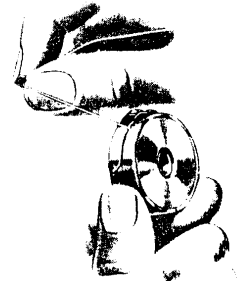

Fig. 8

Then pull the thread into the slot in the edge of the bobbin case as shown in Fig.8; draw the thread under the tension spring and into the delivery eye at the end of the tension spring (see Fig.9).



Fig. 9

Fig. 9

To Replace the Bobbin Case

After threading, take the bobbin case by the latch and place the bobbin case on the center stud (E, Fig. 5) of the bobbin case

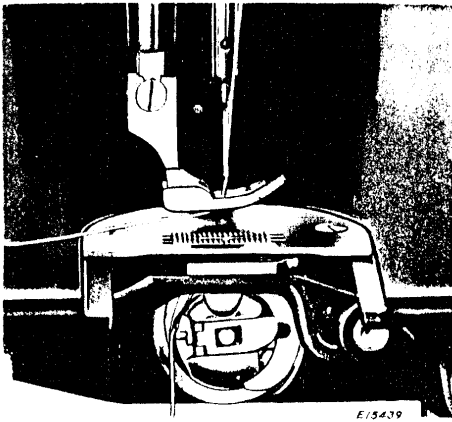

Fig. 10. Bobbin Case Threaded and Replaced

holder; release the latch and press the bobbin case back until the latch catches the groove near the end of the stud (See Fig. 10). Allow about two inches of thread to hang free, and replace the slide in the bed of the machine.

To Set the Needle

Turn the balance wheel over toward you until the needle bar moves up to its highest point; loosen the screw in the lower end of the needle bar and put the needle up into the bar as far as it will go, with the long groove of the needle toward the left and the eye of the needle directly in line with the arm of the machine, then tighten the screw.

Upper Threading

Pass the thread from the unwinder, or from the pin on the top of the machine, from right to left through the top hole (1) in

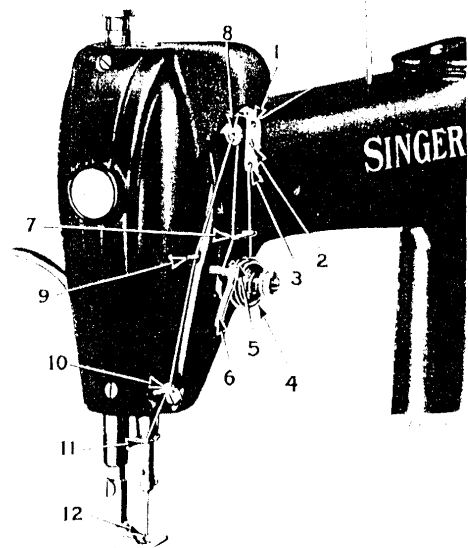
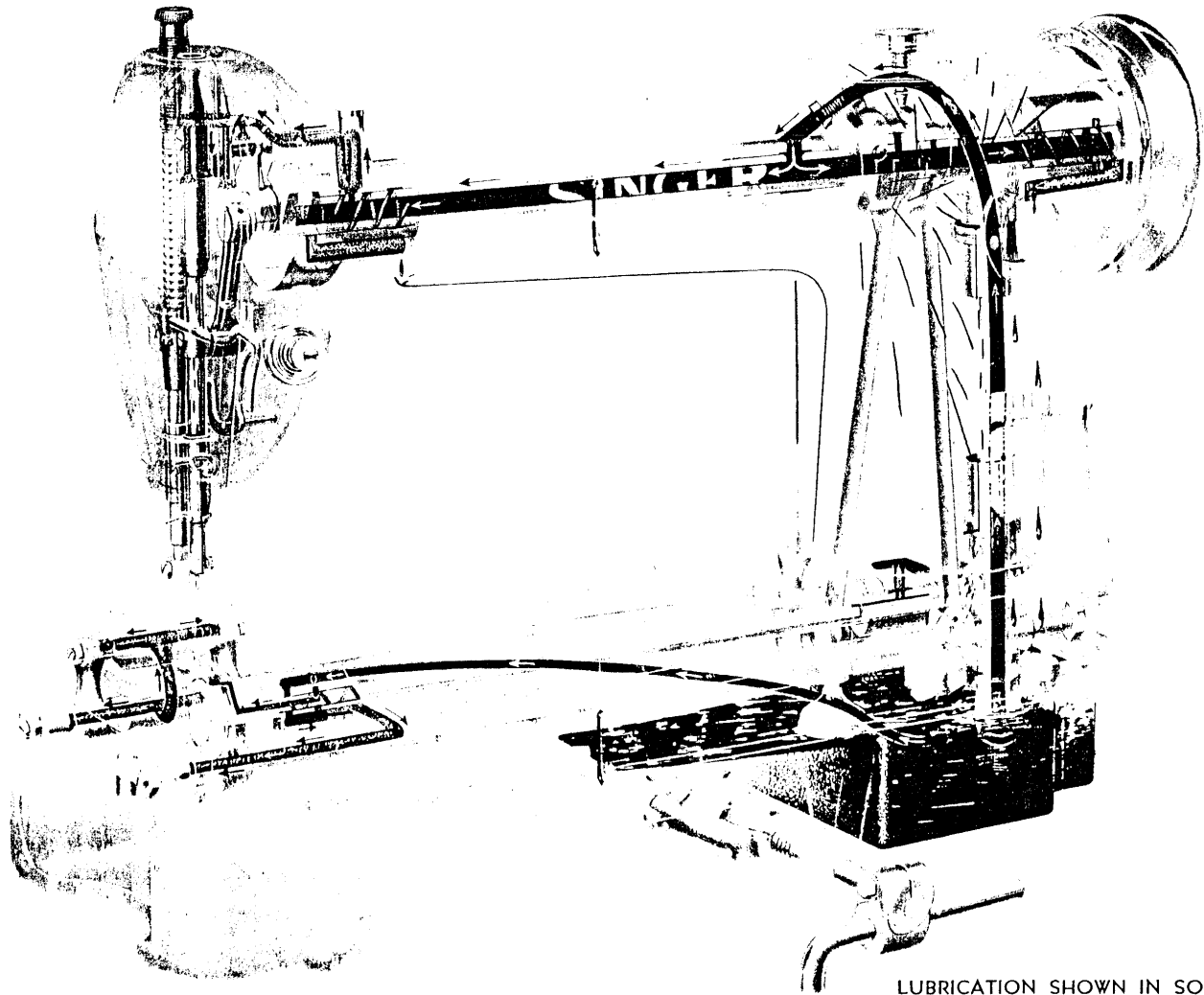

Fig. 11. Upper Threading

the thread retainer, from left to right through the center hole (2) in the thread retainer, and from right to left through the bottom hole (3) in the thread retainer, down under and from right to left between the tension discs (4), into the thread take-up spring (5), under the slack thread regulator (6), up and back of the wire thread guide (7), up and from right to left through the hole in the end of the thread take-up lever (8), down through the thread guide (9), down through the thread eyelet (10), into the thread guide (11), and from left to right through the eye of the needle (12). Draw about two inches of thread through the eye of the needle with which to commence sewing.



LUBRICATION SHOWN IN SOLID BLACK.

To Prepare for Sewing

With the left hand hold the end of the needle thread, leaving it slack from the hand to the needle, turn the balance wheel over

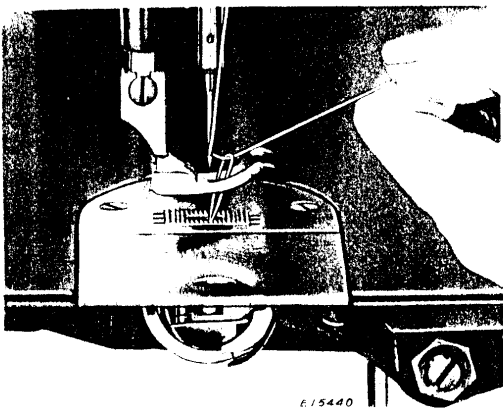

Fig. 13. Drawing Up the Bobbin Thread

toward you until the needle moves down and up again to its highest point, thus catching the bobbin thread; draw up the needle thread and the bobbin thread will come up with it through the hole in the throat plate (see Fig.13). Lay both threads back under the presser foot.

To Commence Sewing

Place the material beneath the presser foot, lower the presser foot and commence to sew, turning the balance wheel over toward you.

To Remove the Work

Let the thread take-up lever rest at its highest point, raise the presser foot, draw the work back and cut the threads close to the goods.

Tensions

For ordinary stitching, the needle and bobbin threads should be locked in the center of the thickness of the material, thus:

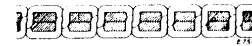

Fig. 14. Perfect Stitch

If the tension on the needle thread is too tight, or if that on the bobbin thread is too loose, the needle thread will lie straight along the upper surface of the material, thus:



Fig. 15. Tight Needle Thread Tension

If the tension on the bobbin thread is too tight, or if that on the needle thread is too loose, the bobbin thread will lie straight along the under side of the material, thus:



Fig. 16. Loose Needle Thread Tension

To Regulate the Tensions

THE TENSION ON THE NEEDLE THREAD SHOULD BE REGULATED ONLY WHEN THE PRESSER FOOT IS DOWN. Having lowered the presser foot, turn the small thumb nut at the front of the tension discs over to the right to increase the tension. To decrease the tension, turn this thumb nut over to the left.

The tension on the bobbin thread is regulated by the large screw (FF, Fig.7) in the tension spring on the outside of the bobbin case. To increase the tension, turn this screw over to the right. To decrease the tension, turn this screw over to the left.

When the tension on the bobbin thread has been once properly adjusted, it is seldom necessary to change it, as a correct stitch can usually be obtained by varying the tension on the needle thread.

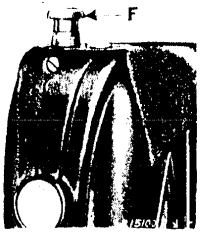

Fig. 17

To Regulate the Pressure on the Material

The pressure on the material is regulated by the thumb screw (F, Fig. 17). To increase the pressure, turn this thumb screw over to the right. To decrease the pressure, turn this thumb screw over to the left.

Length of Stitch

To change the length of stitch, press the plunger (G, Fig. 18) and turn the balance wheel slowly until the plunger drops into a notch in the feed eccentric. Then turn the wheel forward or backward to increase or decrease the length of stitch, which is indicated by the letters on the indicator plate at H. The letter "A" indicates the longest stitch, and the letter "L" the shortest. When the desired setting is obtained, release the plunger. NEVER PRESS THE PLUNGER (G) WHILE THE MACHINE IS RUNNING.

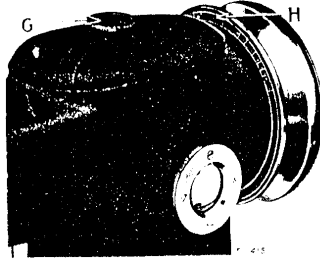

Fig. 18. Stitch Regulator

INSTRUCTIONS FOR ADJUSTERS AND MECHANICS

To Adjust the Thread Take-up Spring

The thread take-up spring (J, Fig. 19) should be set so that when the eye of the needle reaches the goods on the downward

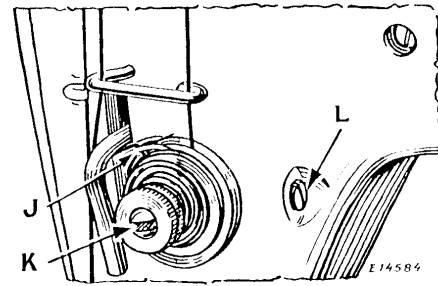

Fig. 19. Adjustment of Thread Take-up Spring

stroke of the needle bar, the spring will be through acting and will rest against the stop on the thread take-up spring regulator. If the thread take-up spring is not correctly set, as instructed above, loosen the set screw (L, Fig. 19) in the arm of the machine, and turn the tension stud (K, Fig. 19) to the right for more movement of the spring or to the left for less movement. When the spring is correctly set, securely tighten the set screw (L).

The tension on the thread take-up spring (J) is regulated by turning the tension stud (K) to the right to increase the tension, or to the left to decrease the tension. The tension on the thread take-up spring should be just sufficient to take up the slack of the needle thread until the eye of the needle reaches the goods in its descent.

Feed Eccentric Stop Screws

The machine is prevented from making longer stitches than a predetermined maximum by the stop screw (M, Fig. 20) in the feed eccentric.

Feed eccentric stop screw 140256, furnished with machine 241-11, permits a maximum length of seven stitches per inch. Stop screw 140258, for 14 stitches per inch or shorter, can also be used. Machines 241-12 and 241-13 are regularly fitted with stop screw 140257 permitting a maximum length of $5\frac{1}{2}$ per inch, but either 140256 (7 per inch) or 140258 (14 per inch) can be used.

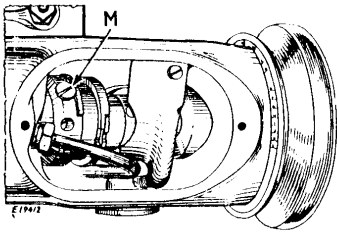

Fig. 20. Feed Eccentric Stop Screw

To Prevent Operators from Changing Stitch Length

The stitch regulator plunger (G, Fig. 18) can be removed to prevent unauthorized persons from changing the stitch length. Take out the small screw near the tip of the plunger, which will allow the plunger to be withdrawn when the stitch length has been adjusted. The hole in the top cover should then be filled by inserting a screw 140317X (not regular equipment).

To Set the Needle Bar at the Correct Height

See that the needle is pushed up into the needle bar as far as it will go, then remove the face plate, lifting it UPWARD.

The needle bar has two timing marks near its upper end. Rotate the balance wheel until the needle bar moves down to its lowest position. The UPPER TIMING MARK on the needle bar should then be centered with the lower end of the needle bar bushing, as shown at Q in Fig. 21. In case the needle bar is not set at the correct height, loosen the clamp screw (R) and move the needle bar up or down until the UPPER TIMING MARK is centered with the lower end of the bushing as shown at Q, then securely tighten the screw (R).

In the event that the setting of the needle bar bushing has been disturbed, thus making it impossible to set the needle bar

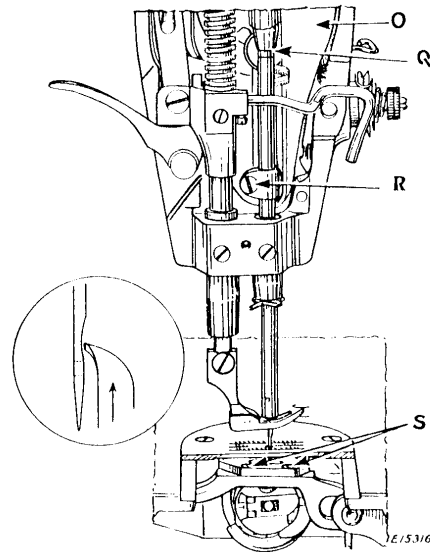

Fig. 21. Needle Bar Set at Correct Height

for correct height by centering the upper timing mark with the lower end of the needle bar bushing, turn the balance wheel to bring the hook point to the center of the needle, loosen screw (R) and move the needle bar up or down to bring the top of the needle eye about $1/32$ inch below the point of the hook (see inset in circle), then securely tighten screw (R). Loosen the needle bar bushing set screw at the top of the machine arm and, while the hook point is at the center of the needle and $1/32$ inch above the top of the needle eye, move the needle bar bushing up or down to bring its lower end exactly even with the LOWER TIMING MARK on the needle bar, then securely tighten the needle bar bushing set screw.

When replacing the face plate, see that the inner oil lead overhangs the top of the take-up lever oil guard (O, Fig. 21).

To Time the Sewing Hook

Remove presser foot, slide plate, throat plate and bobbin case. Take out the two screws (S, Fig. 21) and remove feed dog.

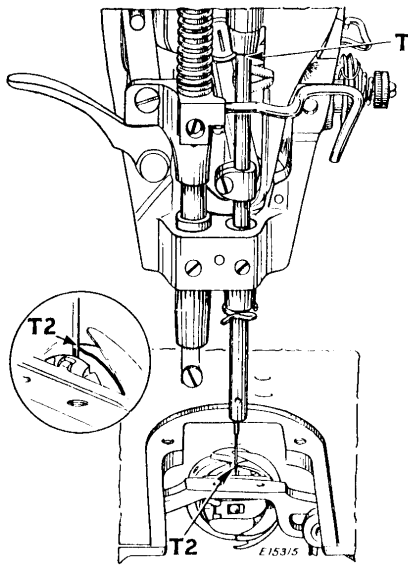

Fig. 22. Needle and Sewing Hook Correctly Timed

To determine that the hook is correctly timed, place a new needle in the machine, then turn the balance wheel over toward you until the LOWER TIMING MARK on the needle bar is centered with the lower end of the needle bar bushing as shown at T (Fig. 22) when the needle bar is on its upward stroke. With the needle bar in this position, the point of the hook should be at the center of the needle as shown at T2 (Fig. 22). The inset in circle at the left of Fig. 22 plainly shows this position of the hook point relative to the needle.

In case the hook is not correctly timed, loosen the three screws in the hub of the hook (at X, Fig. 23) which can be reached

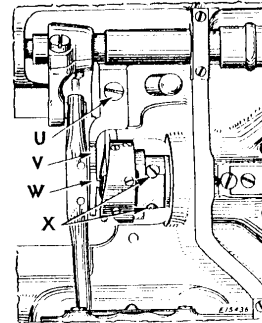

Fig. 23

from the top of the machine with the throat plate off. Turn the hook on its shaft to bring the point to the center of the needle as shown at T2 (Fig. 22), then tighten the three hub screws.

Adjustment of Rotating Hook Oil Flow Regulator

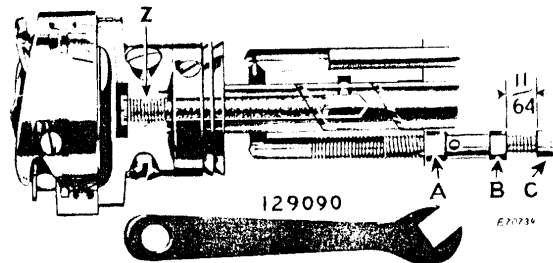

Fig. 24. Oil Flow Regulator (A) in Hook Shaft Bushing

The oil flow regulator is set at the factory for average sewing conditions, with the underside of the head of the oil adjusting screw (C) approximately 11/64 inch from the lock nut (B) as illustrated above.

If more or less oil is desired, loosen the lock nut (B) with wrench No. 129090; turn adjusting screw (C) inward to increase the flow of oil to the hook, or outward to decrease the flow; then hold the adjusting screw (C) while tightening the lock nut (B). To determine the flow, see note on page 7.

To Remove and Replace the Sewing Hook

Remove the needle, slide plate and bobbin case. Take out the screw (U, Fig. 23) and remove the bobbin case holder position bracket (V, Fig. 23). Loosen the three set screws (at X) in the

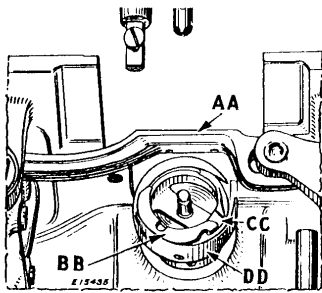

Fig. 25. Showing Correct Position of Thread Guard (DD) and Bobbin Case Holder (BB) for Removal of Sewing Hook

hub of the hook, then turn the balance wheel over toward you until the feed bar (AA, Fig. 25) is raised to its highest point. Turn the sewing hook until the thread guard (DD) is at the bottom, as shown in Fig. 25, and turn the bobbin case holder (BB) until it is in the position shown in Fig. 25. The sewing hook can then be removed from the hook shaft.

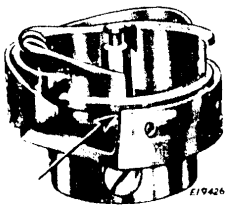

Fig. 26. Correct Position of Bobbin Case Holder in Relation to Sewing Hook When Inserting or Removing Bobbin Case Holder

While the sewing hook is off, it is advisable to replace the oil filter (Z, Fig. 24) in the end of the hook shaft. Unscrew the filter from the center of the shaft and replace with a complete new filter No. 143350, without disturbing the position of the wick in the hollow tube.

When placing a new sewing hook on the shaft, have the thread guard (DD) of the hook at the bottom and the bobbin case holder (BB) turned to the position shown in Fig. 25, so that the hook will clear the feed bar (AA).

When the hook is in position on the shaft, turn the bobbin case holder (BB) until the notch (CC) is at the top, then replace the bobbin case holder position bracket (V, Fig. 23), being careful to see that the position stud (W, Fig. 23) enters the notch at the top of the bobbin case holder, as shown in Fig. 23, then securely fasten the position bracket by means of the screw (U). Replace the needle and time the sewing hook as instructed on pages 20 and 21. Replace the bobbin case and slide plate.

To Remove and Replace the Sewing Hook Shaft

Remove the sewing hook as instructed on page 22.

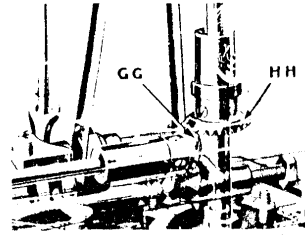

Fig. 27

Before removing the hook shaft from the machine, the gears (GG and HH, Fig. 27) should be marked with chalk or red pencil on one tooth of one gear and the corresponding space in the other gear. This is important, as the gears may become dislodged when removing the shaft, and the marks will enable you to retain the original relative position of the gears.

To remove the hook shaft, loosen the two set screws in the gear (GG, Fig. 27) at the right end of the hook shaft, and hold the gear, with the fingers, in mesh with the gear (HH) while withdrawing the old hook shaft and inserting the new shaft.

Before tightening the two set screws in the gear, see that one of the screws will bear on the flat on the shaft. The hook shaft should have a barely perceptible amount of end play.

Replace and time the hook as instructed above and on page 20.

Removing Needle Bar Link and Thread Take-up

Remove the needle and presser bars, and loosen the two screws (KK and LL, Fig. 28) in the needle bar crank, reached through the

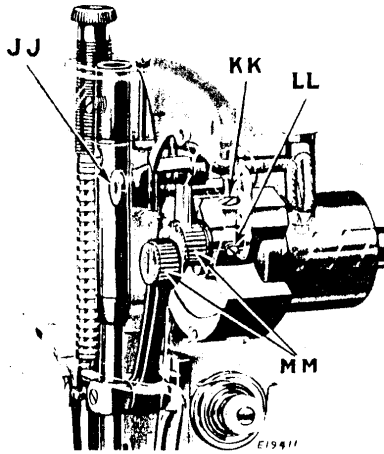

Fig. 28.

opening in the back of the head, also the set screw which holds the take-up link hinge stud (JJ). The needle bar link and take-up assembly can now be removed without disturbing either of the needle bearings (MM), which is not recommended. THERE ARE 18 BEARING NEEDLES IN EACH OF THE TWO BEARINGS (MM) AND THE BEARINGS MUST NOT BE ASSEMBLED WITH ANY LESS THAN THIS NUMBER OF NEEDLES.

When replacing the needle bar link and take-up assembly, first slightly tighten the position screw (LL) against the flat on the take-up crank, then tighten the clamping screw (KK) then loosen screw (LL) and firmly tighten screw (KK) before firmly tightening the position screw (LL).

Timing of the Feeding Mechanism

When the machine leaves the factory, the feed and feed lifting eccentrics are correctly set by having the timing screws in the eccentrics enter the grooves in the arm shaft. If, for any reason, it may be necessary to alter the timing of the feed eccentric, the timing screw should be removed and the eccentric locked in the desired position by means of the set screws only.

OIL PUMP

If it should ever be necessary to remove the oil pump, note that the impeller is held to the shaft by a left-hand thread, and must be turned off to the right after removing the locking screw at the center of the shaft. Be careful not to damage the impeller.

When replacing the impeller, it is important to lock it in a position where it will clear both top and bottom of the case.

CAUTION TO MECHANICS

The Class 241- Machine is made with extreme precision in machining and assembly, and the "Superfinish" process provides microscopically smooth bearing surfaces. Therefore special care should be taken not to permit any misalignment or cause any scratches or nicks on the bearing surfaces by careless assembly or handling of parts. Any such damage might render the machine incapable of the long trouble-free service for which it was designed.

SINGER Needles should be used
in SINGER Machines.
These Needles and their Containers
are marked with the
Company's Trade Mark "SIMANCO.*" 1

Needles in Containers marked
"FOR SINGER MACHINES"
are NOT **SINGER** made needles. 2